

### Application

Brio's Zero Clearance Glass is an ideal internal system for residential and commercial applications for easy operation of toughened glass panels.

Designed to achieve minimal clearances of just 2.5mm between top edge of the glazing rail and underside of the track.

Zero Clearance Glass 80 hangers are equipped with precision bearings.

### Panel Specification

Track System:	Zero Clearance Glass 80
For Individual Panels:	
Max Panel Height	3000mm
Max Panel Width	1500mm
Max Panel Weight	80kg
Panel Thickness	10-12mm

### Standard Packs

Packs include hangers, door stops, glazing rail, glazing bead, guide and handle

Pack No.	Max Panel Width
ZG80-12/1	1200mm
ZG80-15/1	1500mm

### Hardware Specification

Track:	120
Material	Aluminium clear anodised
Standard lengths	2000mm, 3000mm, 4000mm and 6000mm

Accessories:	
Handle	535G
Soft Close	100SCT
Clip Stop	100CS

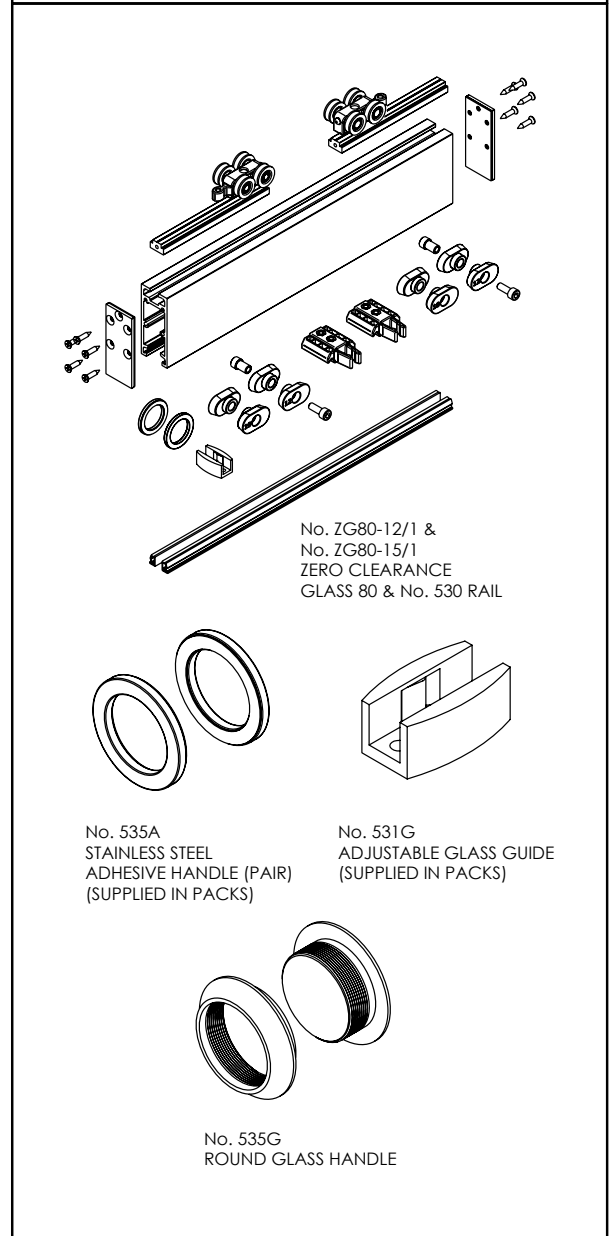
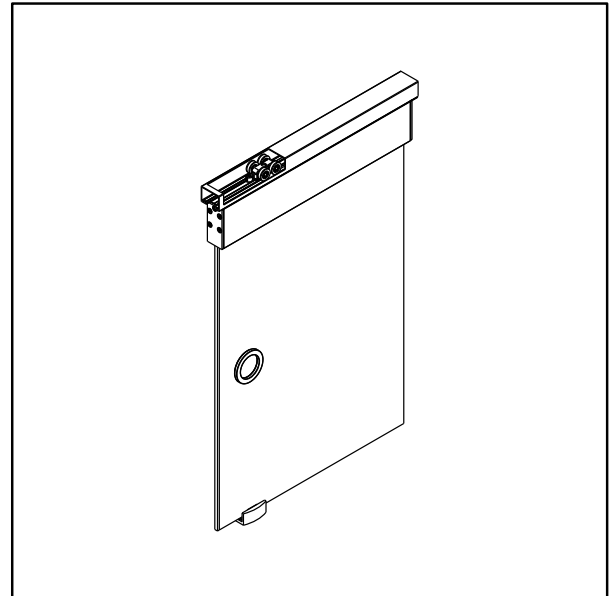

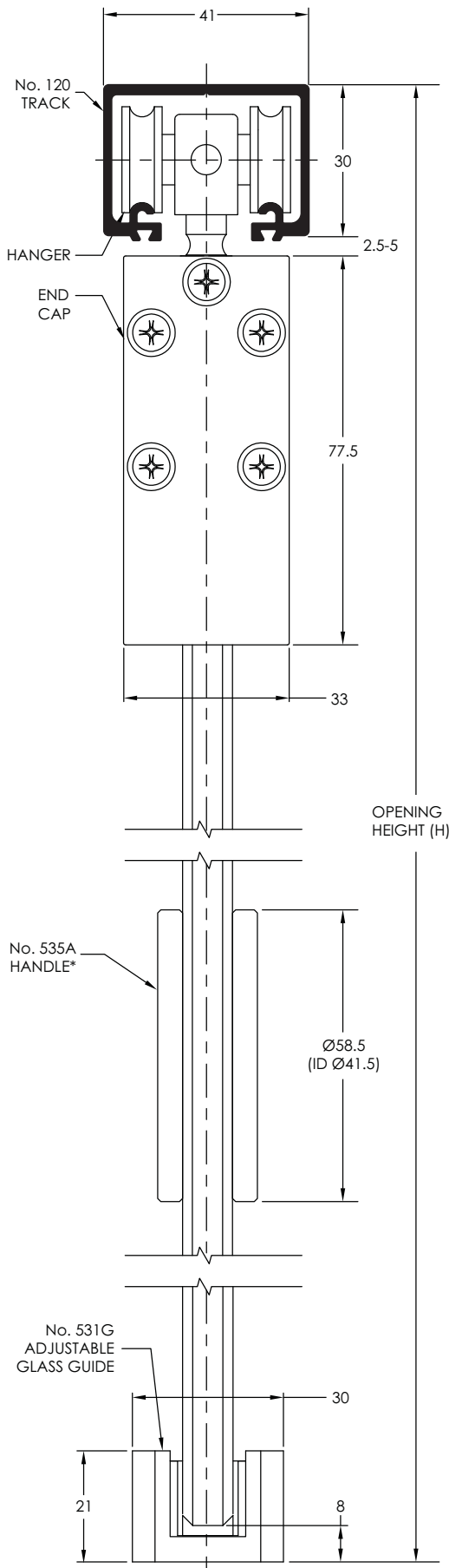

**TRACK FIXING CENTRES**  
35mm FROM EACH END, 400mm MAXIMUM

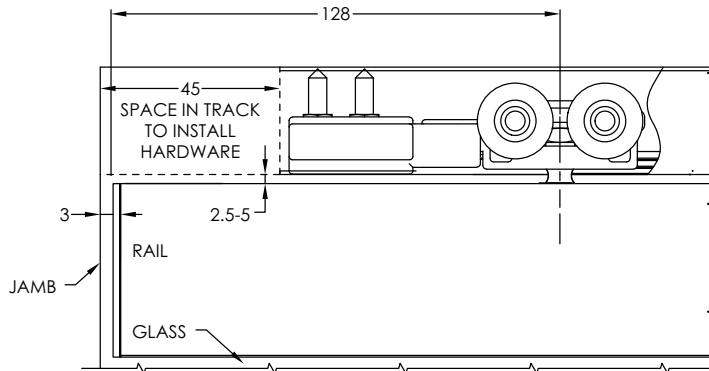

**GLASS PREPARATION FOR ALL HANGERS**  
CUT GLASS SIZE = OPENING HEIGHT (H) - 60mm  
FOR PANELS ≤ 1000mm 2 FIXINGS REQUIRED  
\*FOR PANELS ≥ 1001mm 3 FIXINGS REQUIRED

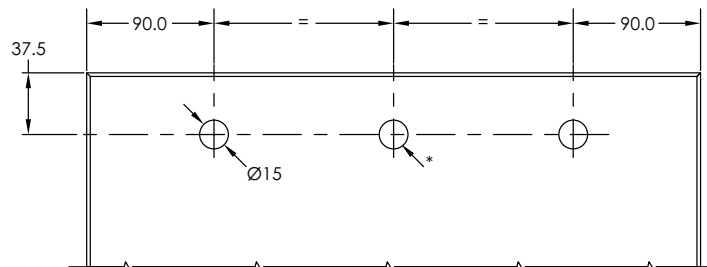

**INSTALLATION**

1. CHOOSE FITTING FOR 10mm OR 12mm GLASS.
2. CLAMP INTO PRE-DRILLED HOLES USING 5mm ALLEN KEY
3. INSERT CLAMPS INTO RAIL

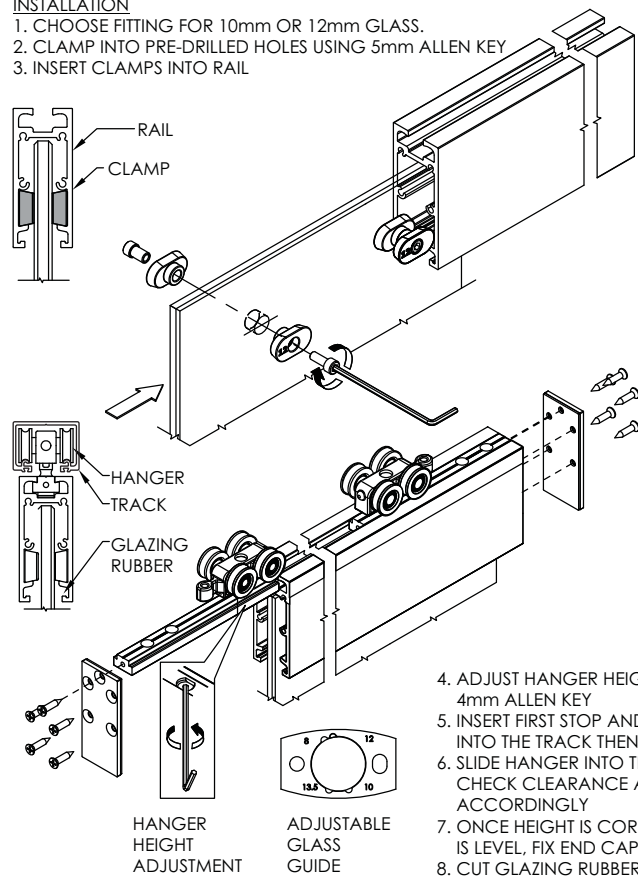

4. ADJUST HANGER HEIGHT USING 4mm ALLEN KEY
5. INSERT FIRST STOP AND HANGERS INTO THE TRACK THEN THE LAST STOP
6. SLIDE HANGER INTO THE RAIL. DOUBLE CHECK CLEARANCE AND ADJUST ACCORDINGLY
7. ONCE HEIGHT IS CORRECT AND PANEL IS LEVEL, FIX END CAPS ONTO THE RAIL
8. CUT GLAZING RUBBER TO THE LENGTH OF THE RAIL AND USING DETERGENT PUSH IN. APPLY BOTH SIDES
9. PREPARE GUIDE ACCORDING TO THICKNESS OF GLASS. FIX GUIDE TO OVERLAPPING AREA OF OPENING

\* FOR No. 535G ROUND GLASS HANDLE, MACHINE A Ø50 HOLE TO FIT HANDLE