

Application

Suitable for interior top hung sliding panels.

Ideal for residential situations where economy is of major importance.

Suitable for a single panel or for two panels on a bi-parting installation - panel width limits apply.

The track is sidewall fitted with provision for a 'hook-on' pelmet.

All screws are the same size and length for quick selection and easy installation.

Panel Specification

Track System:	Sprintline 30
For Individual Panels:	
Max Panel Weight	30kg
Max Panel Width	1500mm
Min Panel Thickness	25mm

Suitable for use with lightly constructed timber framed panels of flush or panelled construction.

Provision must be made for fitting the hangers securely, since the hangers strike the door stops.

Standard Sets and Packs

Sets comprise of top track, hangers, door stops, guide, all timber screws and installation instructions.

Set No.	Max panel width	Track Length
SL30-16/1	900mm	1600mm
SL30-24/1	1500mm	2440mm

Pack No.
SL30-1PK Pack of fittings only, without track, for use with one SL30-24/1 set for bi-parting panels, each 720mm maximum width.

Hardware Specification

Track:	169
Material	Aluminium, Mill
Standard lengths	1600mm and 2440mm

Track includes recess for 'hook-on' pelmet.

Hanger (2 per panel): 168

The steel hanger is zinc plated and includes a nylon tyred ball race wheel for smooth operation. Enables an easy, finite height adjustment when panel hanging.

Door Stop: 263

The steel door stop is zinc plated and includes a rubber buffer. The multiple holes in the plate and the fact that the buffer is reversible, allows precise adjustment for stopping the panel.

Guide: 55G

Guide in white nylon, comes in two parts that fit on both sides of the panel. The guide is floor mounted.

Accessories:
Pelmet 170

Pelmet in pearl white on aluminium. Hooks onto track, no screws required. Supplied with End Caps. Available in 1800mm and 3050mm lengths.

End Caps 170C

Made from high impact glass reinforced nylon. The End Caps are a push-fit onto the pelmet.

Alternative Guide 102WA

Guide in zinc plated steel, has lateral adjustment. Fits on the wall or architrave, in the overlap area, and slides through a 20mm deep by 5mm wide sawcut in the bottom rail of the panel. Floor left free of hardware.

Alternative Guide 103WA

Guide in white nylon, fits on the wall or architrave, in the overlap area, no need to groove the panel, since the guide supports the panel faces. The guide is adjustable for panels from 35mm to 45mm thick. Floor left free of hardware.

Alternative Guide 101N

The nylon guide is designed to slide through a 20mm deep by 5mm wide sawcut in the bottom rail of the panel. The guide is fitted on the floor at the edge of the opening in the overlap area. The guide has lateral adjustment.

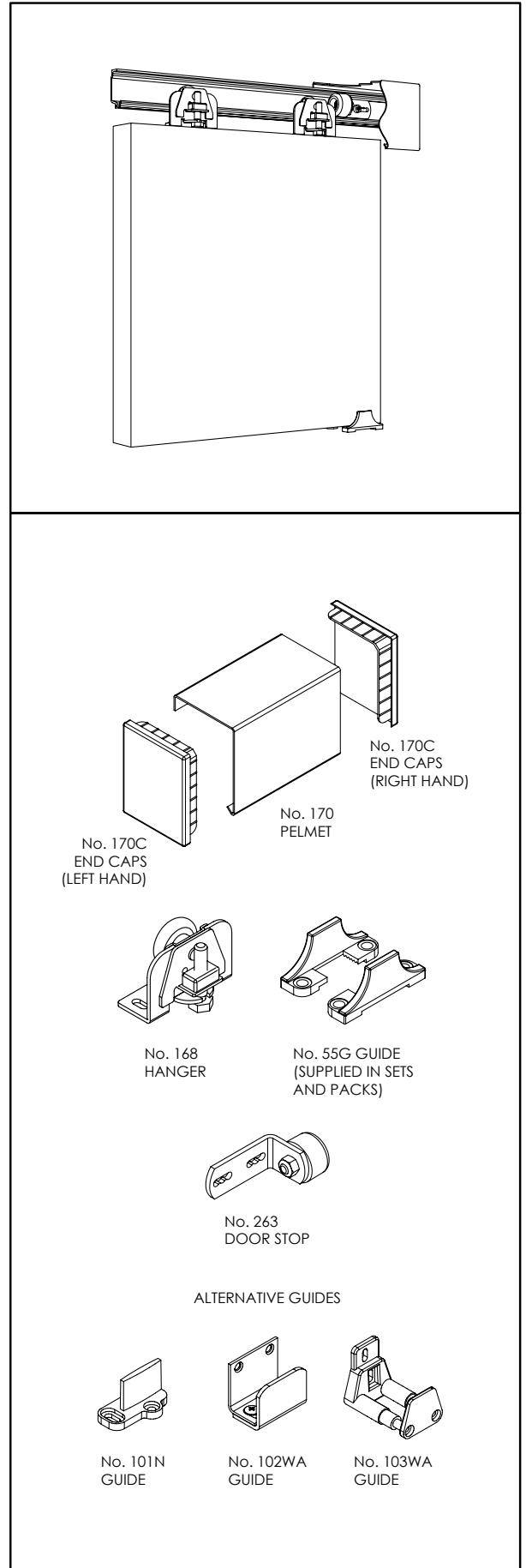

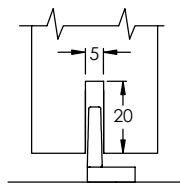
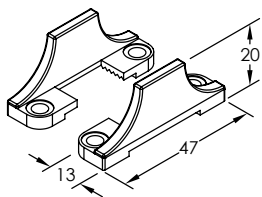
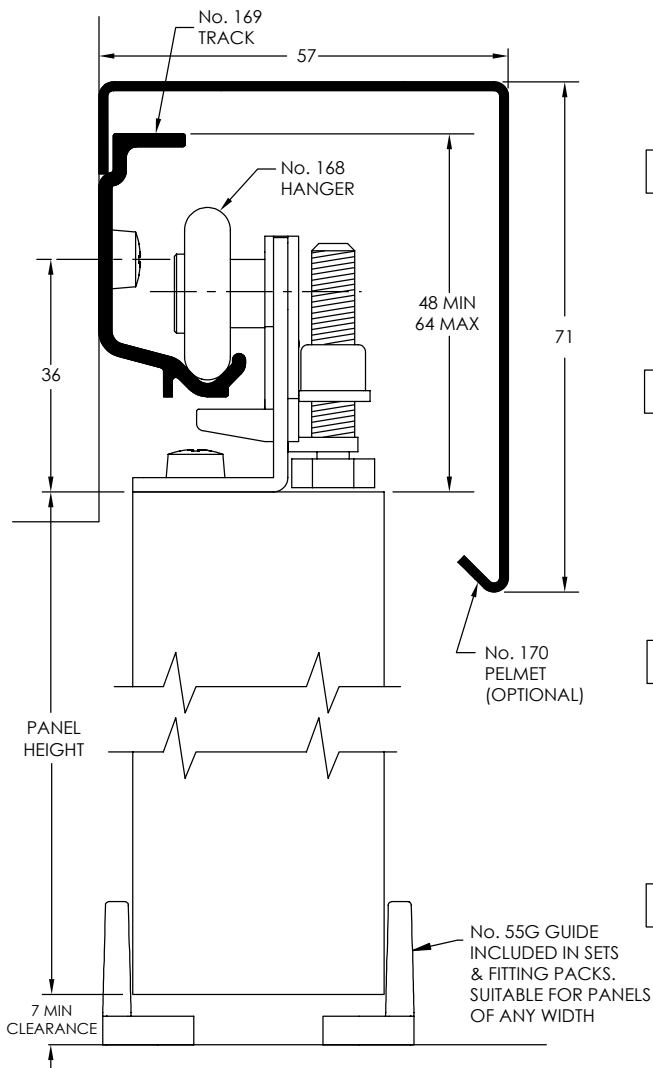

ALTERNATIVE GUIDES

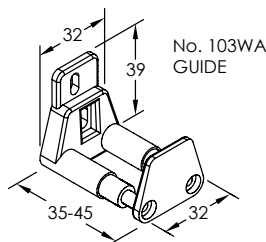
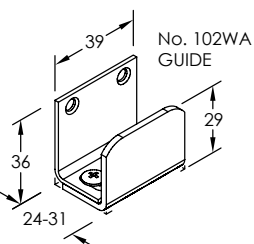
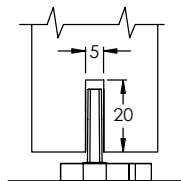
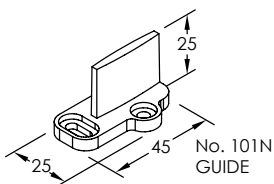

INSTALLATION INSTRUCTIONS

NOTE: All screws are the same type, size and length for quick installation. (Plus 4x6g screws for guide)

1 Fit Track Parallel to Floor

Add 36mm and required floor clearance to panel height. This is the distance between finished floor and track screws. Position centre of track directly in line with opening jamb. Screw track to wall using pre-punched holes.

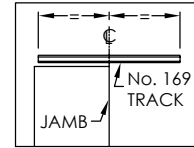

2 Fit Hangers to Panel

Hanger bracket should be positioned flush with inner face of panel. Measurement 'X' for panels up to 1370mm equals 1/6 of panel width. Over 1370mm measurement 'X' equals 340mm. For Bi-Parting panels 720mm wide, fix outside hangers 220mm from edge of panel and inner hanger 15mm from edge of panel.

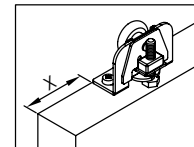

3 Lift Panel on to Track

Lift panel at an angle, wheels towards track. Hook hanger onto track and straighten panel. Loosen screws of hanger bracket to adjust side clearance.

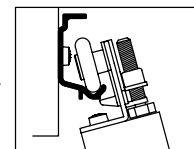

4 Adjust Panel

Screw adjustment bolt of hanger to adjust panel height. Adjust panel height so panel is square.

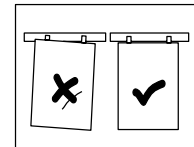
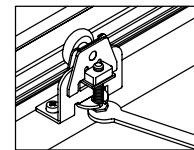

5 Fit Guide

Locate at opening jamb. With panel hanging plumb fix guides to either side of panel.

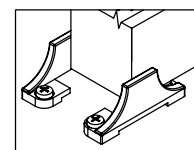

6 Position Door Stops

Fit one stop to each end of the track, screw through track. With panels over 765mm reverse the buffer so that the panel will open fully. Reverse buffer when used in centre for bi-parting panels

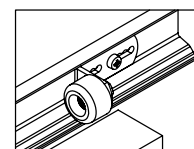

7 Pelmet - Optional Extra

The pelmet hooks onto the track and end caps simply "push fit" into position.

(Note: For panels over 20kg additional screw fixings may be added between each existing hole. Screws not supplied.)

